

Storage solutions



Titus®

Drawer solutions

17mm drawer slide

- Runners are paired in one piece moulding
- The guide rail steers the drawer and reduces jamming risk
- Integral drawer stop and hole plugs
- Manufactured in HDPE to provide a smooth glide action

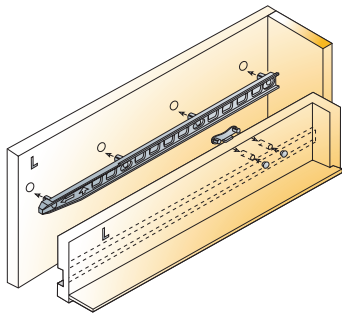

Technical and mounting details

17mm slide pair

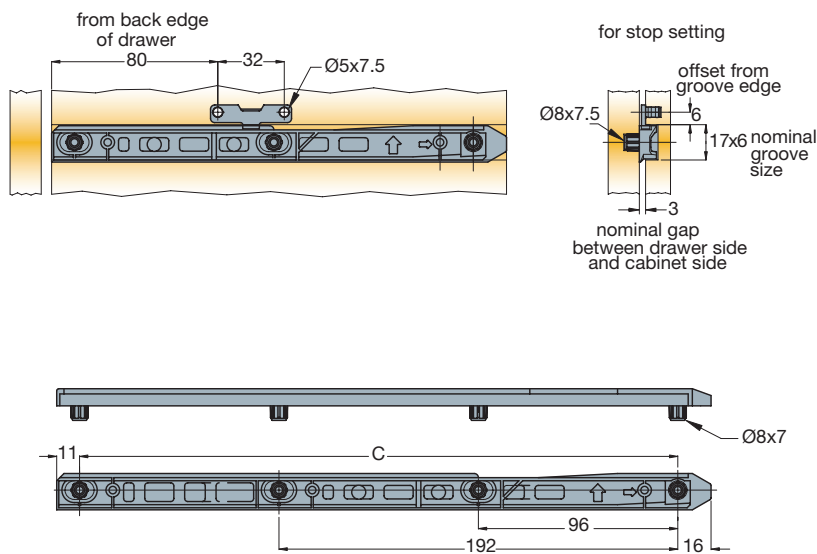

C	Item number	Color	
		Neutral	Powder grey
192	05179 →	846	886
260	05364 →		886
288	05184 →	846	
288	*05201 →	846	

*American market only

One set consists of:

- 2 pcs slides
- 2 pcs stops





100 Sets

Made of plastic

Drawer solutions

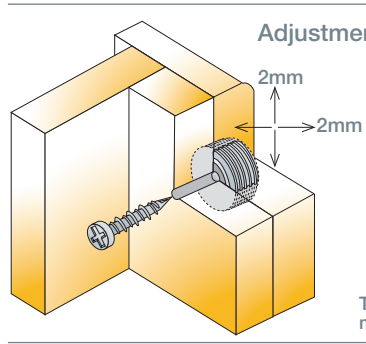
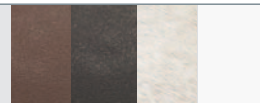
Drawer front adjuster (DFA)

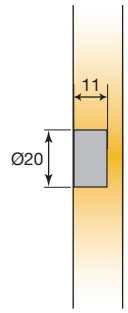
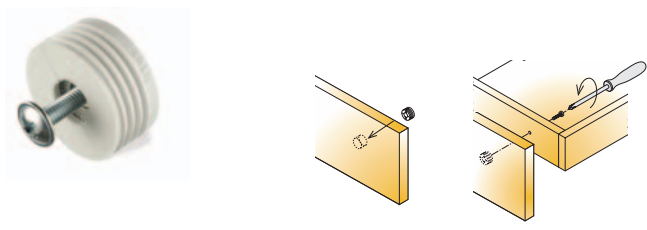
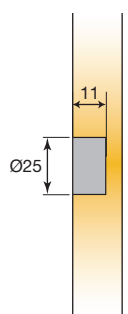
- Multi-direction adjustment
- Locking screw to fasten
- Independent of drawer system
- One piece housing

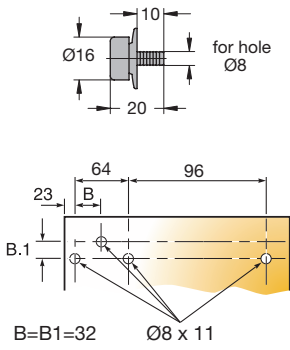
 <p>Adjustment range 2mm 2mm</p> <p>Technical and mounting details</p> <p>Before After</p>				
Item number	Dark brown	Black	Nickel	White
<p>DFA housing</p>   <p>2500 Pcs Made of plastic</p>	06308 →	831		877
<p>DFA housing</p>   <p>2500 Pcs Made of zinc, plastic</p>	06310 →	831		877
	*06309 →	831		877
	*00033 →		847	
	*American market only			
	*06309 does not include screw			
<p>Runner wheel</p>   <p>4000 Pcs Made of plastic</p>	00900 →	831 835		877

Wardrobe/Closet solutions

Soft-open shoe rack

- Smooth open-close mechanism
- Wheel runners provide a simple and smooth operation
- Teeth provide a ratchet action slowing down the opening and closing
- Webbing design feature protects children from trapping fingers

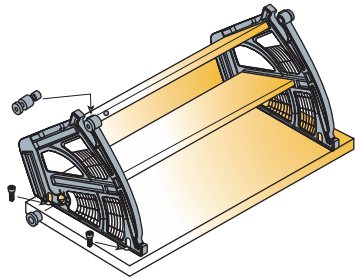

Technical and mounting details

Shoe rack

3 compartments

Item number

Black

White

08053 →

835

877

2 compartments

08055 →

835

877



side panel

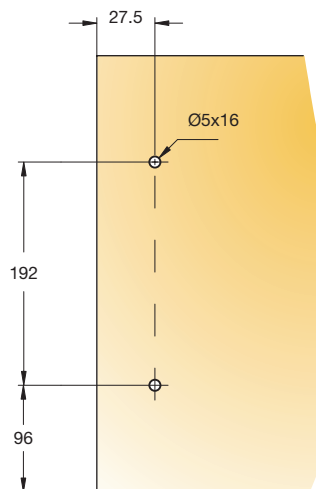

door panel

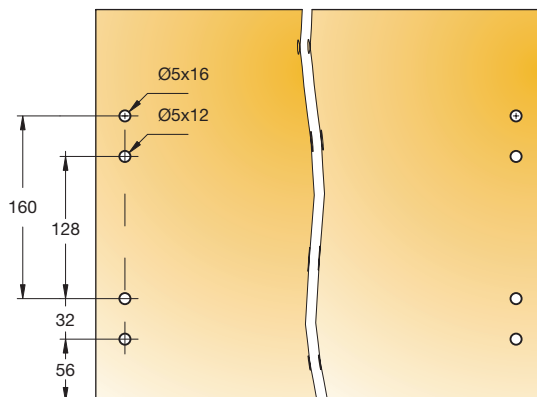

We recommend the using of Panhead screws No. 600019

Pivot and roller wheel included

96 Pcs

Made of plastic

Soho™ solutions

DVD storage columns

- Clip feature so CDs do not fall out
- Mounted vertically or horizontally
- Simple mounting
- Click on decorative cover caps
- Stackable

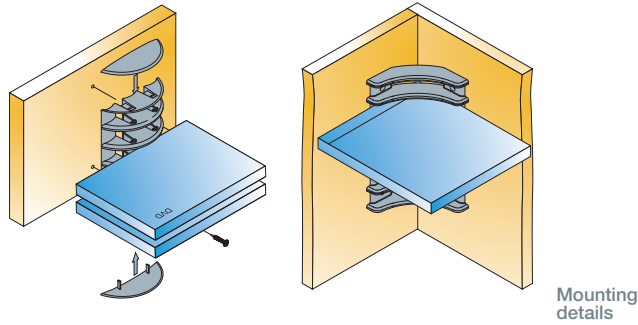

DVD/CD storage columns

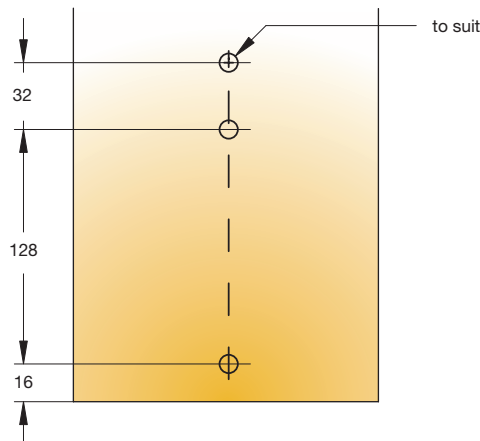

100 Pcs

Made of plastic

No. of CDs/DVDs	Item number	Color	
		Black	Silver
6	04637 →	835	861

DVD/CD corner storage columns

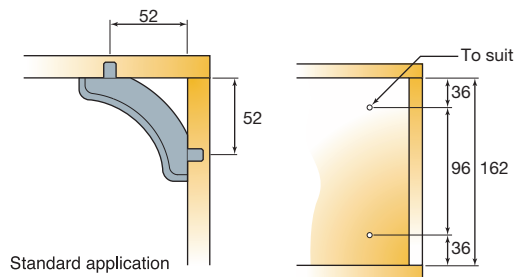

Standard application

Back-to-back application

Overall height is 162 mm,
Repeat module is 160 mm.

140 Pcs

Made of plastic

7	04645 →	835	861
---	---------	-----	-----

End caps → see page 6.6

Soho™ solutions

Media storage racks

- Fix using screws or adhesive pads
- Back to back fixing feature
- Fold flat options provide packaging solutions
- DVD and/or CD storage versions available

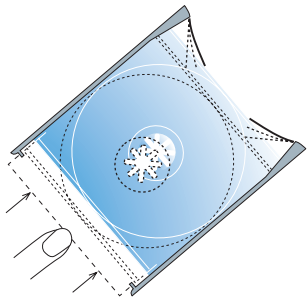

Mounting details

CD media storage racks

	No. of CDs	A	B	Item number	Black	Silver
fold flat	10	96	133	04229 →	835	861
fold flat	20	128	133	04304 →	835	861
DVD	16	128	201	04488 →	835	861

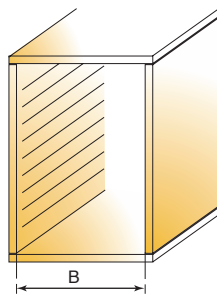
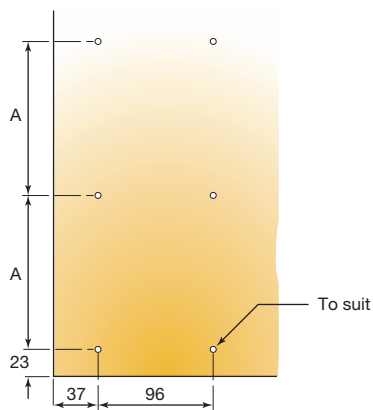





100 Pcs (04229)
 50 Pcs (04304)
 40 Pcs (04488)

Made of plastic

Soho™ solutions

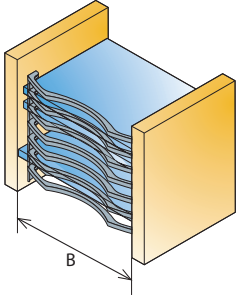
Media storage grills

- DVD and/or CD storage versions available
- Suitable for various mounting applications
- Products can be stacked to increase storage capacity
- Backstop available for maximum design flexibility

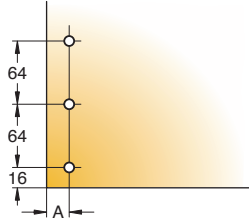
 <p>Mounting details</p>	A	Nc. of CD/DVDs	B	Item number	 Tangerine tint	 Black	 Silver
CD/DVD storage grills	17	9	133	04435 →	829	835	861
 							

 100 Pcs

Made of plastic

Soho™ solutions

Media storage trays

- Spring retainers secure and eject CDs
- Horizontal shelf-mounting with 3 screws
- Free-standing vertical panel attachment - mounted with Quickfit 6408
- Simple conversion of cabinet, shelf or drawer to CD storage

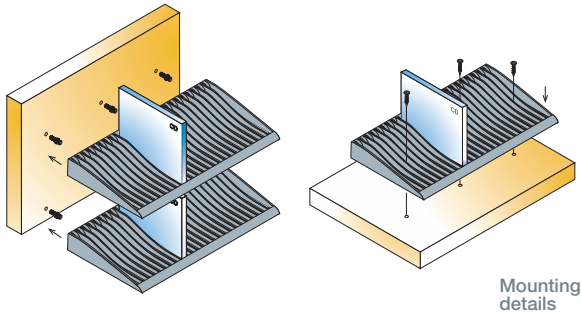

CD storage tray

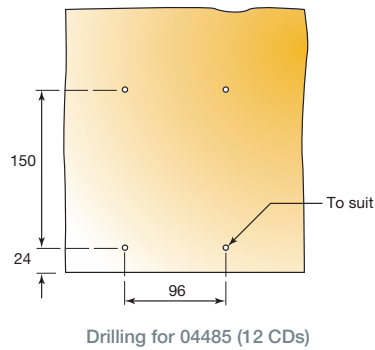
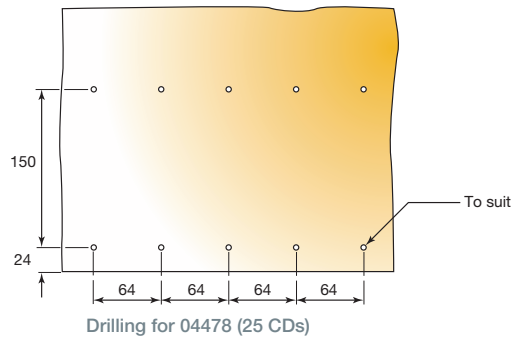

B	Nr. of CDs	Item number	Color	
			Black	Silver
	25	04478 →	835	861
	12	04485 →	835	861

60 Pcs (04478)
84 Pcs (04485)

Made of plastic

Soho™ solutions

Modular swivel

- Designed to clip together to suit panels for wide-screen TVs
- Kit design gives packaging benefits
- Smooth and quiet operation
- Slim design for discrete fitting

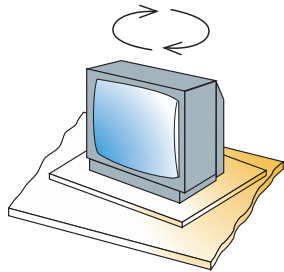

Mounting details

B

Item number

Black

Modular media turntable

06042 →

835

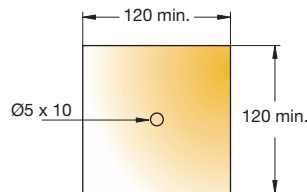
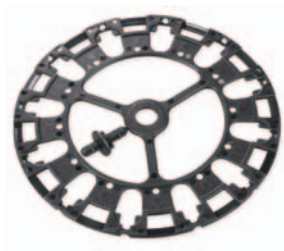

400 Pcs

Made of plastic

Modular media turntable

650

06052 →

835

500

06054 →

835

800

06051 →

835

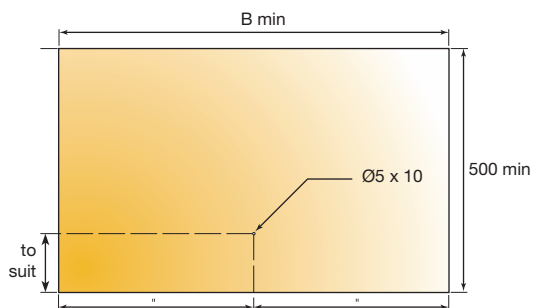
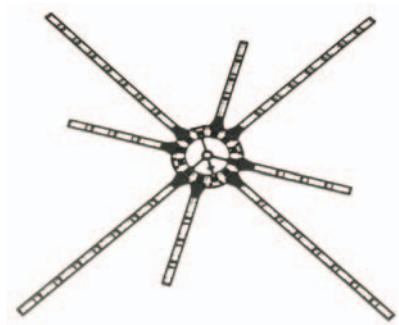

50 Pcs



500 Pcs (06054)

Made of plastic

Soho™ solutions

Turntable

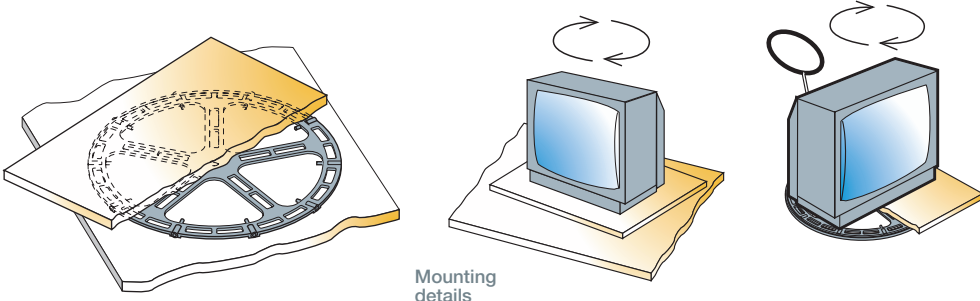
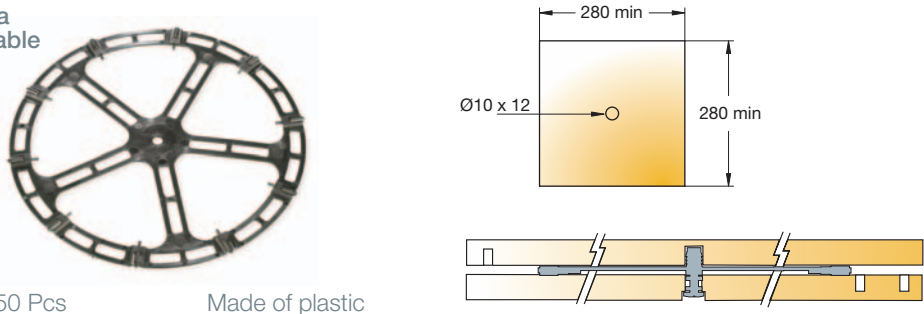
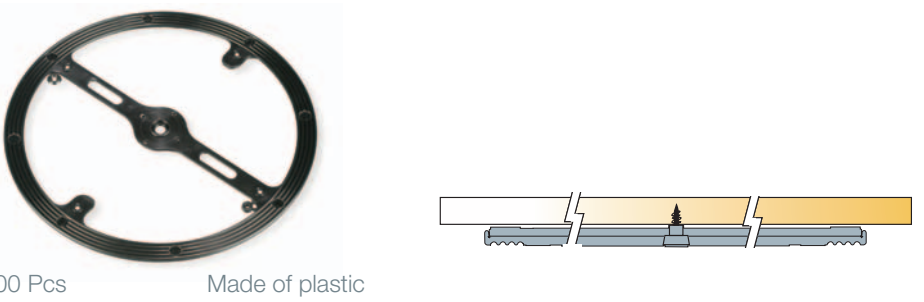
- Weight limit 80kg-100 kg
- Smooth and quiet operation
- Slim design for discrete fitting
- Optional swivel stops to set rotational limits
- Optional slimline tray can be used in a free-standing application

		Item number	Black	Silver	Zinc
 <p>Mounting details</p>					
Media turntable	 <p>150 Pcs Made of plastic</p>	05880 →	835	861	
Turntable tray	 <p>100 Pcs Made of plastic</p>	05876 →	835	861	
Axle bolt	 <p>use insert 02172</p> <p>500 Pcs Made of zinc, plastic</p>	05874 →			885
Glide stopper	 <p>Min. 2 pcs required</p> <p>Made of plastic</p>	05877 →	835		

Inserts
Made of plastic → see page 1.60

Soho™ solutions

Rotating organiser

- Smooth rotation between open and closed position
- Mounts anywhere, easy installation
- Click feature provides a stop in closed and fully open positions
- Half round or quarter storage versions

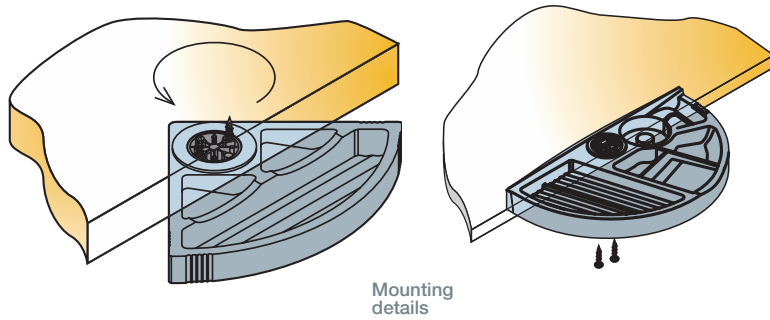

Item number

Black

Silver

Quarter turn desk organiser

04644 →

835

861

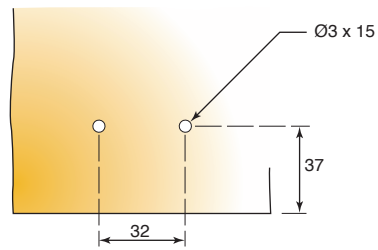

112 Pcs

Made of plastic

Half turn desk organiser

*04490 →

835

861

* European market only

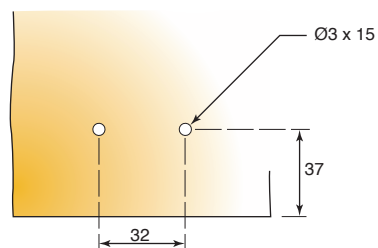

30 Pcs

Made of plastic

