

Glissando
Soft Closing

Glissando Soft Closing Systems for Hinges

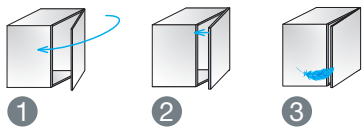

ConfidentClose

- 1 Fast closing
- 2 Late start of deceleration action
- 3 Quiet landing with 'SoftTouch'

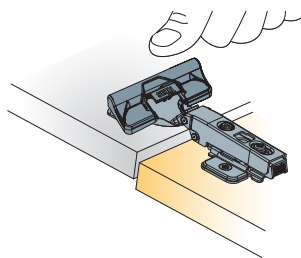

Tool-less mounting

- Reduced assembly time
- Flexible usage also as a retrofit option

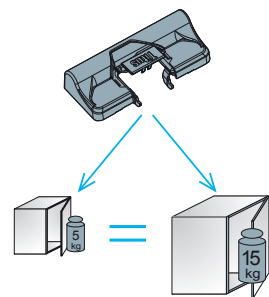

Consistent Performance

- Only one Glissando for two to three hinges
- Allows for consistent performance on a wide range of door dimensions and weights

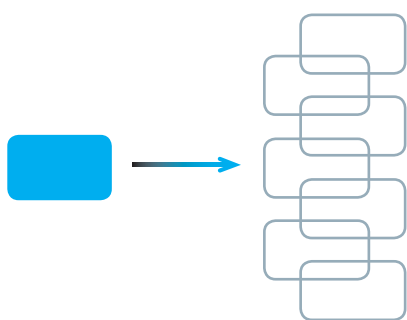

One-for-all

- One item fits multiple applications
- Same item can be used on all crankings and angled hinges



Titus Damper Inside

- Titus proprietary multi-purpose damping technology
- Efficient modular design
- Reliable and consistent damping

Glissando Add-on

Soft Closing Range

How to Choose the Right Glissando?

Glissando TT
 Glissando TL3
 Glissando TL 170
 Glissando CR
 Glissando AL

Titus Glissando soft closing system is available for the whole range of hinge applications. The user can choose between add-on or stand-alone solutions.

Concealed hinges	Add-on hinge soft closing solutions			Stand-alone door soft closing solution	
	Glissando TT	Glissando TL3	Glissando TL 170	Glissando CR	Glissando AL
T-type 95	X			X	X
T-type 110	X			X	X
T-type 110/15°	X				
T-type 110/30°	X				
T-type 110/45°	X				
T-type 110/90°	X				
T-type 120	X			X	X
T-type 170			X	X	X
S-type 110		X		X	X
S-type 110/15°		X			
S-type 110/24°		X			
S-type 110/30°		X			
S-type 110/45°		X			
S-type 110/90°		X			
S-type 170			X	X	X
S-type 110 AL					X
B-type 110		X		X	X
B-type 110/30°		X			
B-type 110/45°		X			
B-type 110/90°		X			
B-type 170			X	X	X
B-type 110 AL					X



Titus Glissando soft closing devices can't be used with unsprung and reverse spring hinges.

Glissando TT 'One-for-all'

T-type

- One item fits multiple applications
- Same item can be used on all crankings and angled hinges
- Designed to fit the concealed hinge cup
- Tool-less mounting
- Suitable for different types of cabinets for kitchens, living rooms, bathrooms and other furniture

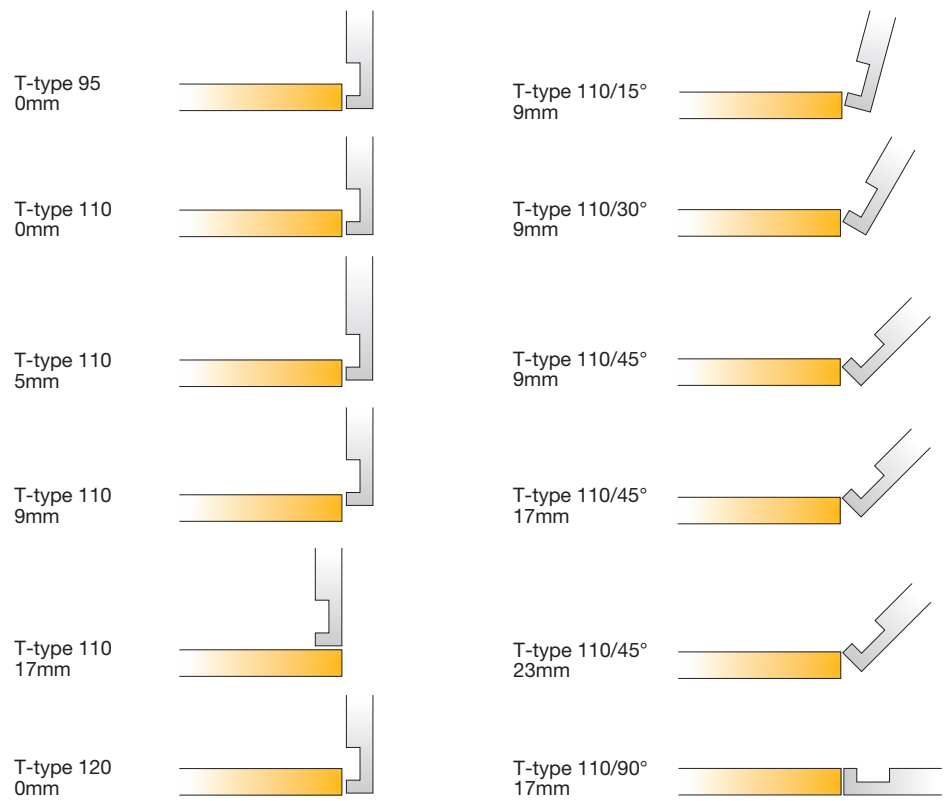
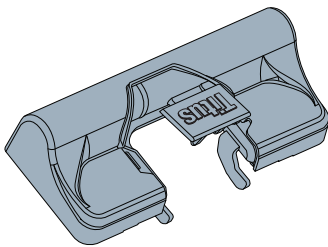

Glissando

Application

Glissando TL3 'One-for-all'

S-type B-type

- One item fits multiple applications
- Same item can be used on all crankings and angled hinges
- Adjustable damping enables perfect functioning on every door
- Designed to fit the concealed hinge cup
- Tool-less mounting
- Suitable for different types of cabinets for kitchens, living rooms, bathrooms and other furniture

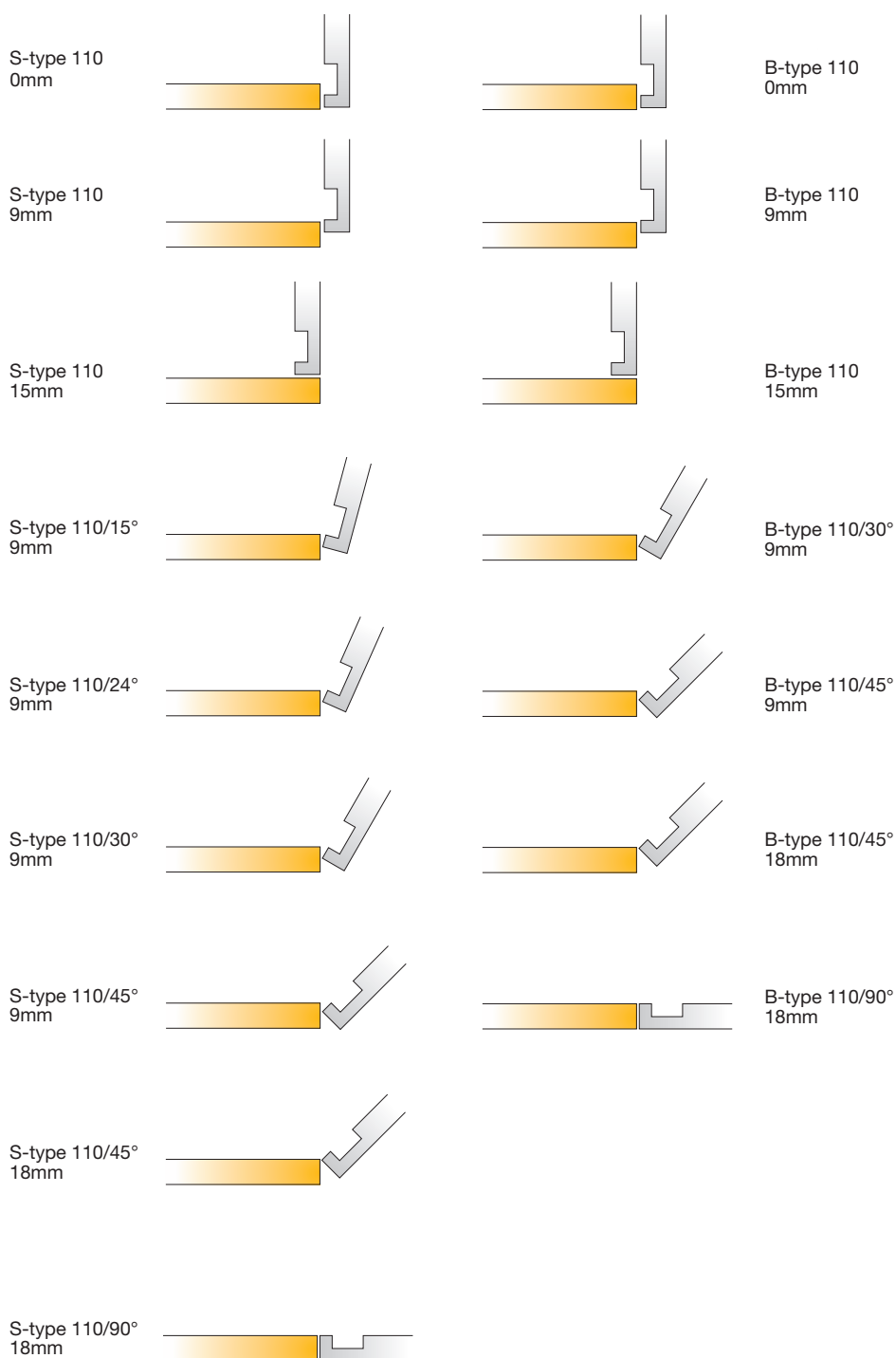
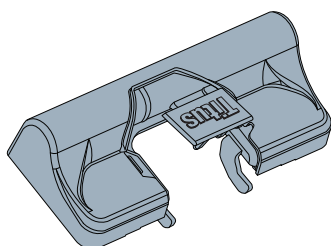

Glissando

Number per Door and Positioning

How Many Glissandos per Door?

Add-on hinge soft closing solution

Glissando TT
Glissando TL3
Glissando TL 170

Number of Glissando per door depends on door dimensions, door weight, hinge arrangement. Trial mounting is recommended.

Glissando TT

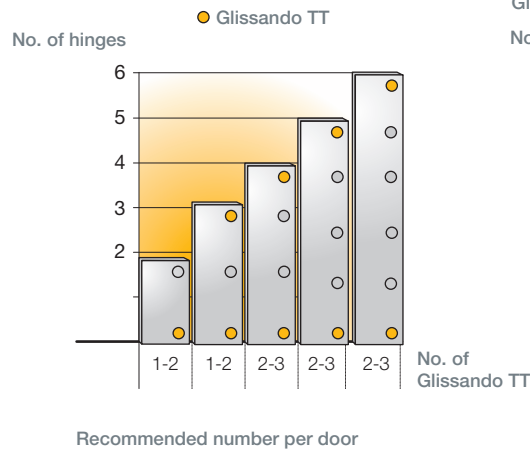

Glissando TL3
Glissando TL170

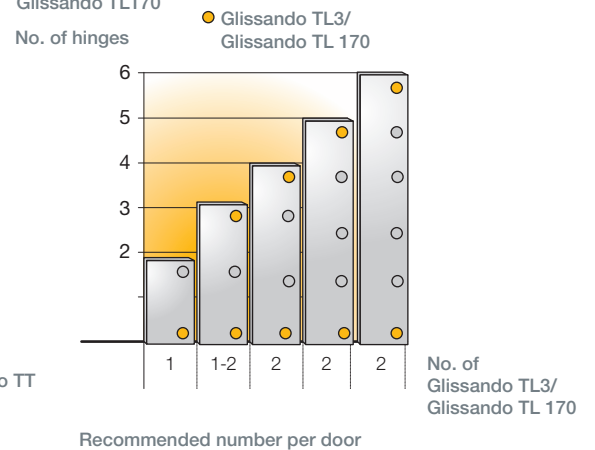

Stand-alone soft closing solution

Glissando CR
Glissando AL

Mount Glissando CR/AL on the hinged side of the cabinet on the top or bottom.

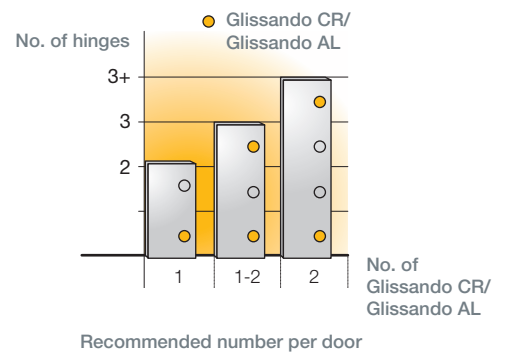

Glissando Mounting

How to Mount Glissando?

Tool-less mounting

Glissando TL3
Glissando TT
Glissando TL 170

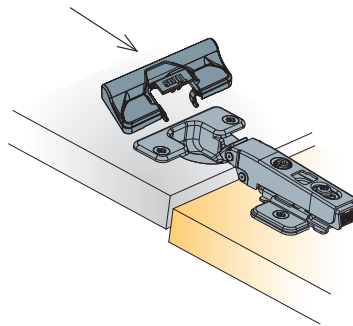

Simple tool-less assembly: Insert Glissando into the holes on the hinge and press down with hand.

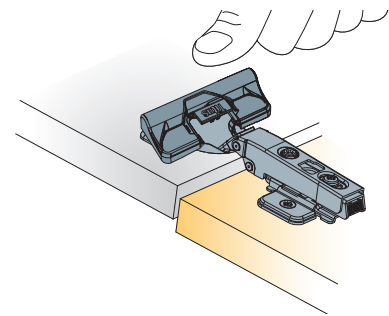

The tool-less 'snap on' version for reduced assembly time and flexibility of application. Glissando TL can be mounted at any time after furniture assembly so can be offered as a retro fit option by the installer.

Screw-on into the cabinet corner

Glissando CR

Glissando CR is mounted into the cabinet corner by using chipboard screws 20mm long.

Glissando dampers' discreet design enhances the look of the door and occupies minimal space in the cabinet interior.

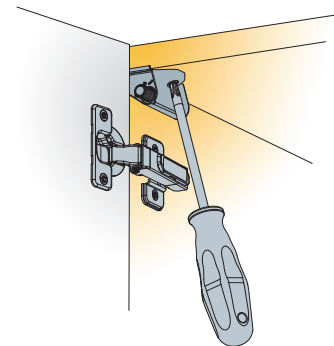

Screw-on onto the mounting plate

Glissando AL

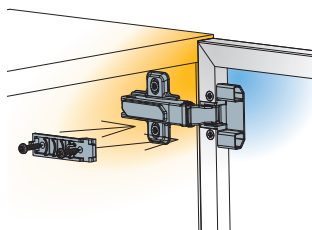

Position the mounting plate below the hinge arm and fix with two screws. Use hinge mounting plate as a reference.

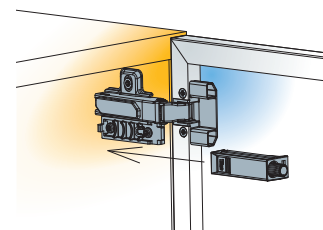

Slide Glissando AL onto the mounting plate

Glissando

Damping Adjustment

How to Adjust Damping?

Add-on hinge soft closing solution

Glissando TL 170

Glissando features quarter turn adjustment to provide optimal closing speed for any door dimensions and weight.

The damping function can be adjusted to fit different door weights which enables

- perfect door functioning
- use of the same type of Glissando for various doors

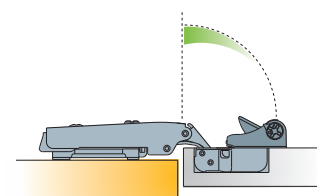

Adjustable damping zone

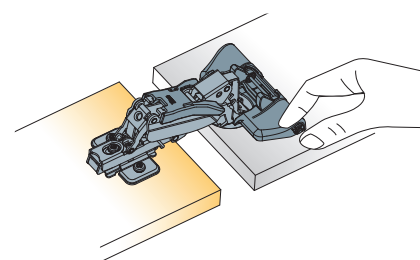

Turn towards '+' to increase and '-' to decrease the damping

Stand-alone soft closing solution

Glissando CR
Glissando AL

Turn towards '+' to increase or towards '-' to decrease the damping.

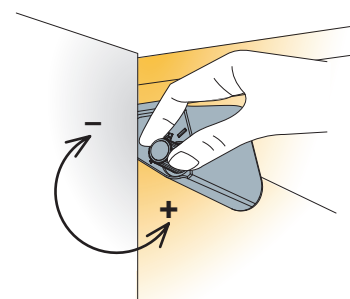

Damping adjustment

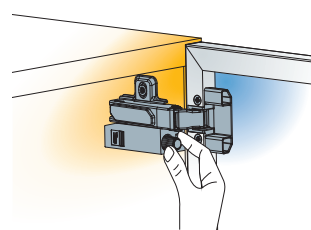

Turn towards '+' to increase and '-' to decrease the damping

- Simple mounting
- Intuitive damping adjustment



Glissando TT

Glissando TL3

Add-on Hinge Damper

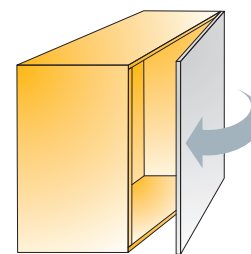
For 95°, 110° and 120° hinges

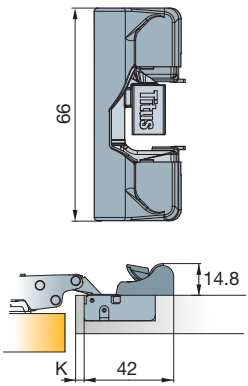

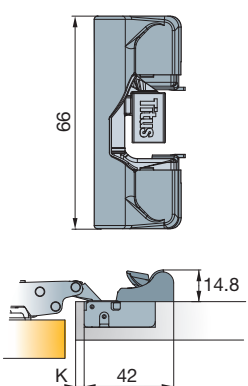
Technical details		Hinge opening angle	Item number
<p>Glissando TT</p> <ul style="list-style-type: none"> · T-type 95 · T-type 110 · T-type 120  <p>200 Pcs Made of steel and plastic</p>		95°, 110°, 120°	729-0K71-054
<p>Glissando TL3</p> <ul style="list-style-type: none"> · S-type 110 · B-type 110  <p>200 Pcs Made of steel and plastic</p>		110°	951-0D45-054

- Same item can be used on most of crankings and angled hinges
- Intuitive snap-on mounting
- Low protrusion in cabinet interior
- Consistent performance across a broad range of furniture doors

Mounting details

Tool-less mounting

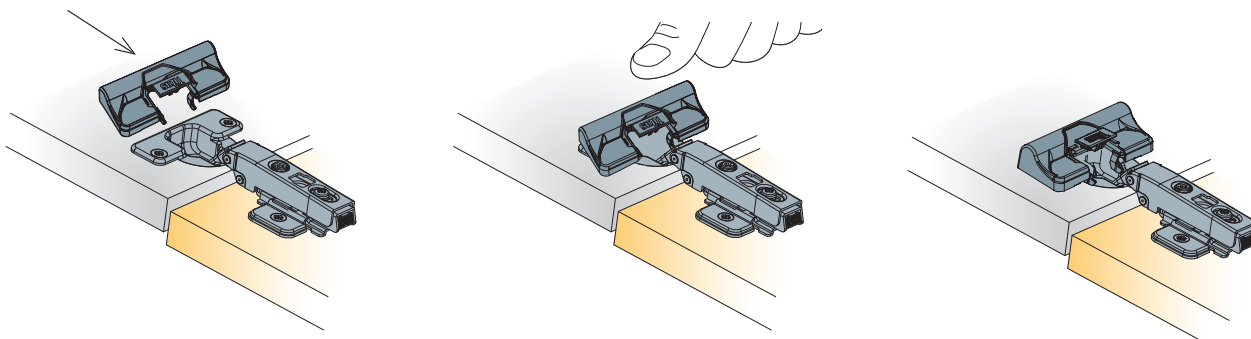

Insert Glissando TL3 into the holes on the hinge

Press down

Dismounting details

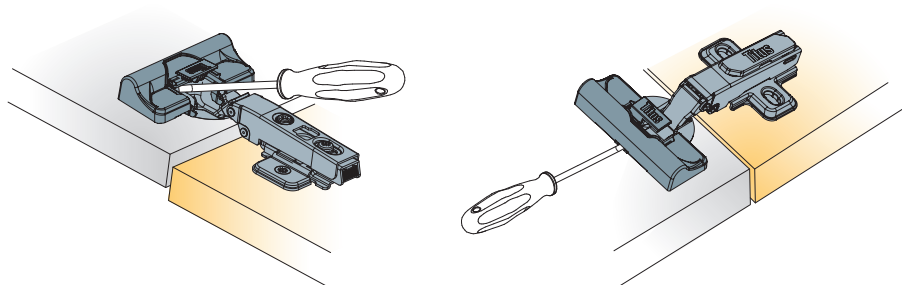

Use flat screwdriver

A trial mounting is always recommended.

Recommended number of Glissandos per door

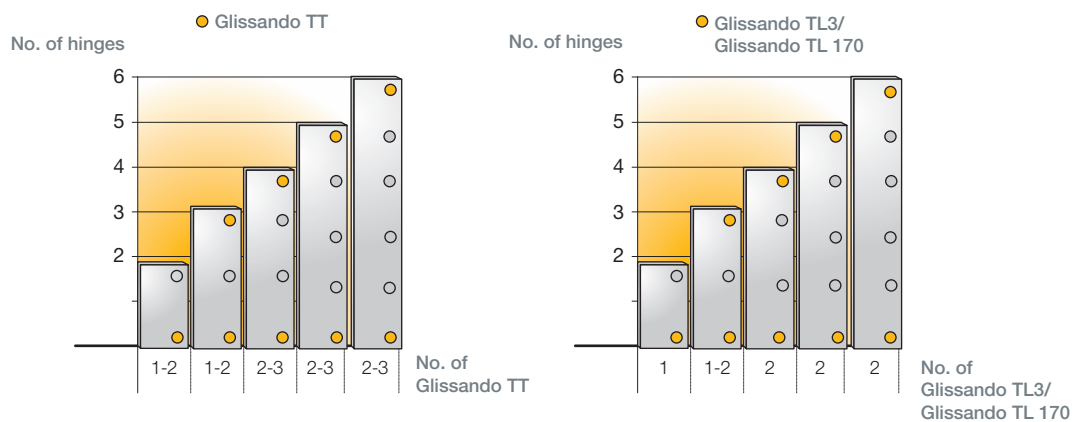

Glissando TL 170

Add-on Hinge Damper

For T-type 170, S-type 170 and B-type 170 hinges

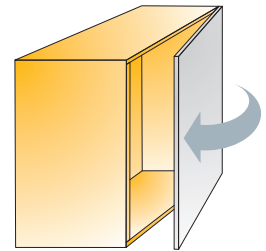
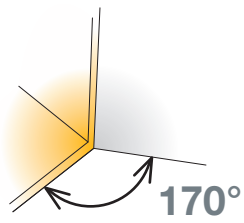

Technical details

Hinge opening angle

Item number

Glissando TL 170

170°

951-0F15-650



Soft closing mechanism

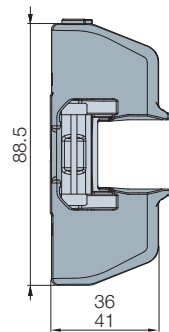

Box content
100 pcs soft closing mechanisms
100 pcs striking plates



Striking plate

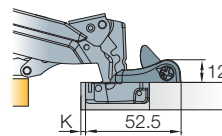

 100 Pcs Made of steel, plastic and zinc

- Gentle and reliable soft closing on doors with wider opening angle
- Fits perfectly 45/9.5mm, 48/6mm and 52/5.5mm hinge cups
- ConfidentClose
- Tool-less mounting

Damping adjustment

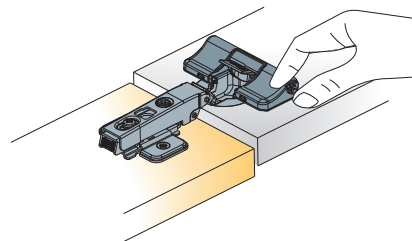

Turn towards '+' to increase and '-' to decrease the damping

Mounting details

Tool-less mounting

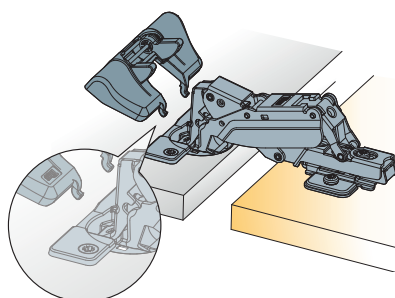

Insert Glissando TL 170 into the holes on the hinge cup

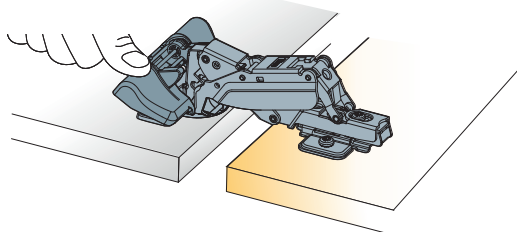

Press down

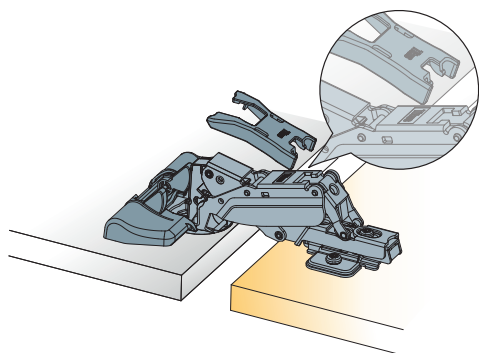

Place the striking plate into the hole on the hinge arm

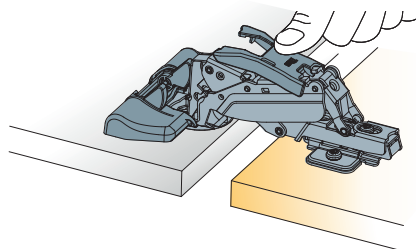

Press down

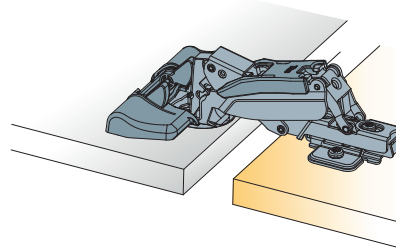

Recommended number of Glissandos per door

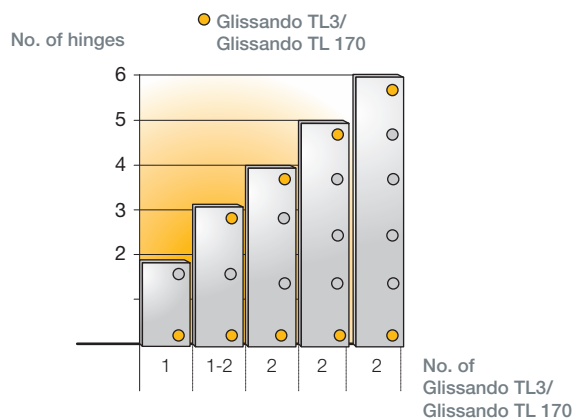

Glissando AL

Add-on Hinge Damper

For 20mm aluminium frame doors

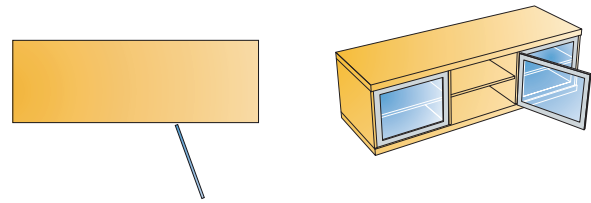

- Simple mounting
- Intuitive damping adjustment



Technical details

Item number

Grey

Glissando AL

972-0420 →

380

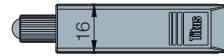
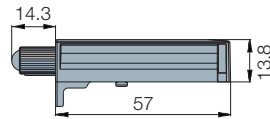

200 Pcs

Full overlay mounting plate

972-4564 →

380

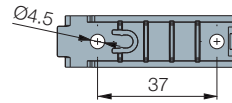
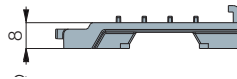

200 Pcs

Half overlay mounting plate

972-4565 →

380

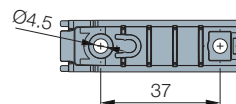
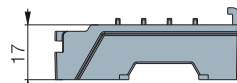

200 Pcs

Inset door mounting plate

972-4566 →

380

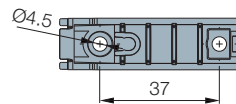
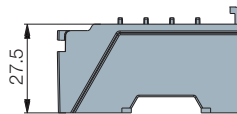

200 Pcs

Hinge cup screws
If not pre-mounted

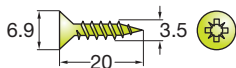

972-6344-042

1000 Pcs

- Simple mounting
- Intuitive damping adjustment
- Use with B-type AL hinges

Damping adjustment

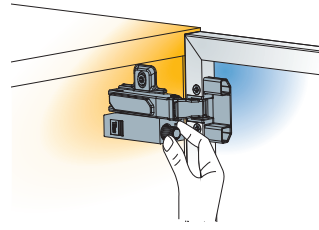

Turn towards '+' to increase and '-' to decrease the damping

Mounting procedure

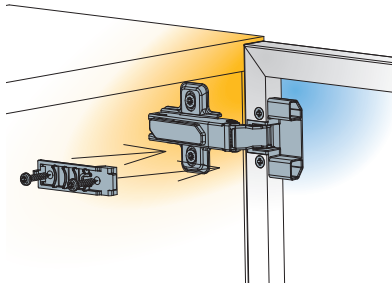

Position the mounting plate below the hinge arm and fix it with two screws. Use hinge mounting plate as a reference.

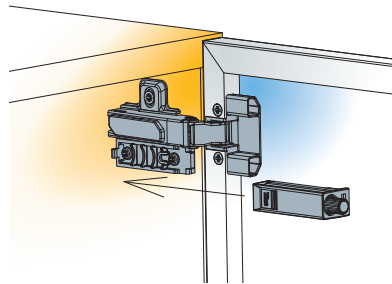

Slide Glissando AL onto the mounting plate.

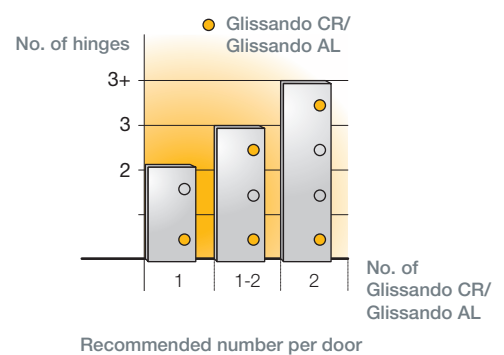
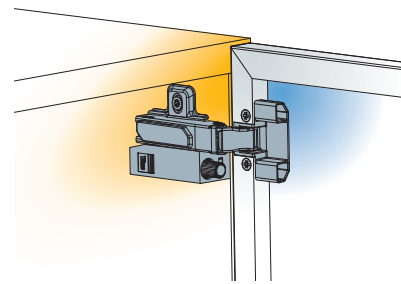

Glissando CR

Stand-alone Damper

For full overlay and half overlay
concealed hinges

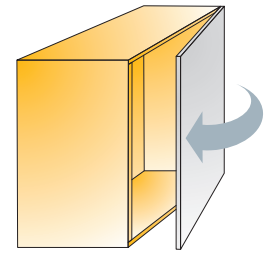

Technical details

Hinge opening angle	Cranking	Item number	White housing	Grey housing	Beige housing
---------------------	----------	-------------	---------------	--------------	---------------

Glissando CR
for full overlay
hinges



Nominal 11
(Adjustment: Nominal + 5mm)

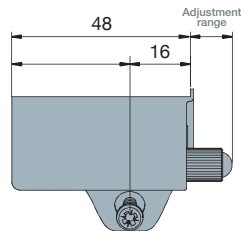

110°	0mm, 5mm	972-0X19 →	350	380	360
------	-------------	------------	-----	-----	-----

*Fixing screw included in a set

100 Pcs Made of plastic

Glissando CR
for half overlay
hinges



Nominal 10
(Adjustment: Nominal + 5mm)

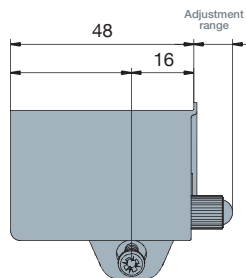

110°	9mm, 17mm	972-0X34 →		380	
------	--------------	------------	--	-----	--

*Fixing screw included in a set

100 Pcs Made of plastic

- Intuitive 'place and fix' installation in the corner of the cabinet
- Tool-less damping adjustment
- One item for a wide range of doors
- Reliable performance
- Can be paired with all self-closing hinges

Damping adjustment

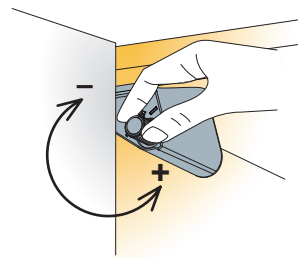

Turn towards '+' to increase and towards '-' to decrease the damping

Mounting details

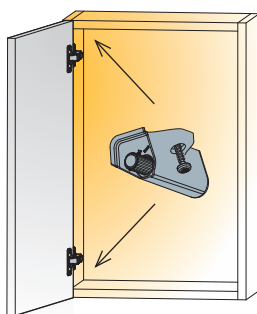
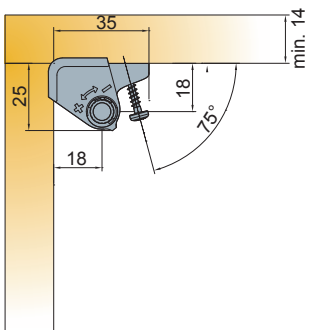

Mount Glissando CR on the hinged side of the cabinet

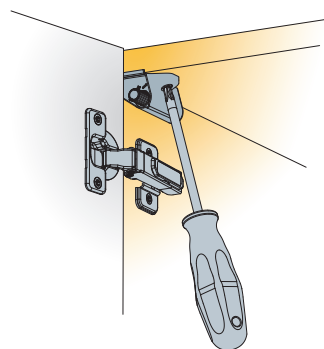

One screw fixing

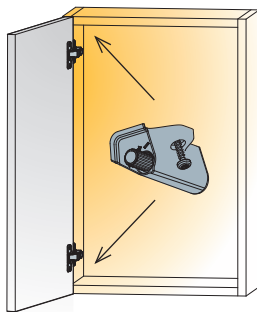
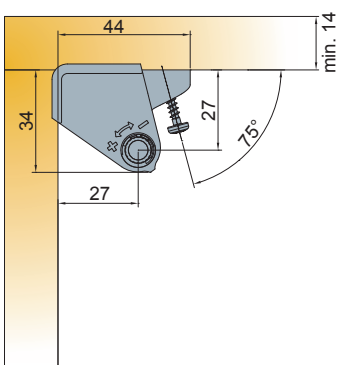

Mount Glissando CR on the hinged side of the cabinet

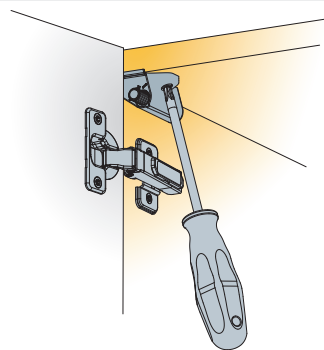

One screw fixing



The functioning of Glissando CR depends of the hinge's closing force. A trial mounting is always recommended.

