

PushOpen Solutions for Hinges

TouchControl Solutions



Push Latch S3

- Soft push opening system controls the outward motion for smooth, silent, and bounceless door movement
- Integrated damper ensures a soft landing, protecting the cabinet and enhancing user comfort

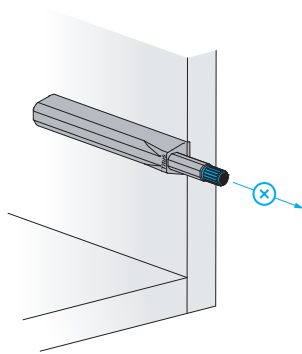

Built-in SafeGuard

- For enhanced safety, adjustment button can't be removed
- Prevents from misuse



Noir, elegant and discreet dark finish

- Seamless integration of hardware into the furniture
- Uniform and discreet surface

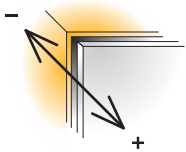

Toolless door gap adjustment

- Easy to compensate any door gaps that might occur during installation
- Adjustment button designed for smooth, hand-operated adjustment



Titus damper inside

- Push latch S2 and S3 version ensure controlled, soft and silent door opening
- Smooth user experience without door rebound
- Cushioned door landing

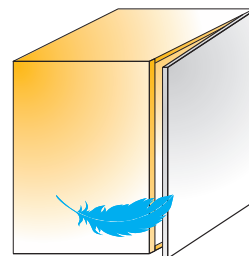

Reliable performance

- Reliable door opening and closing through the life-time

Push Latch S3

For all door types

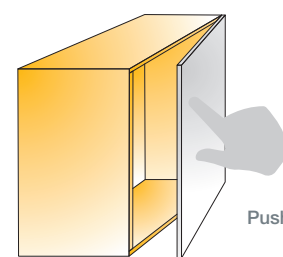

Technical details

Item number

Dusty white

Anthracite

Black

Push Latch S3 with housing

915-9277 →

356

383

390

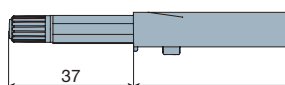
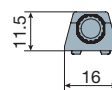

Linear mounting plate

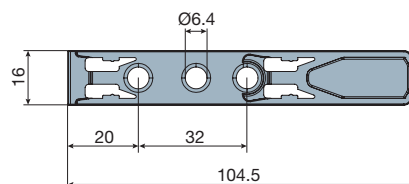

 200 Sets Made of plastic

Fixing screws for mounting plates

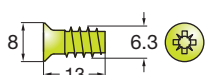

Euro screws
821-6323-050

 5000 Pcs

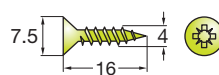

Chipboard screws
820-6328-050

 10000 Pcs

- Soft and silent push opening
- Door gap adjustment ensures reliable closing and consistent performance
- 'Safety click' feature for easy detachment of the mechanism from its mounting plate
- Lip on the mounting plate assures accurate positioning

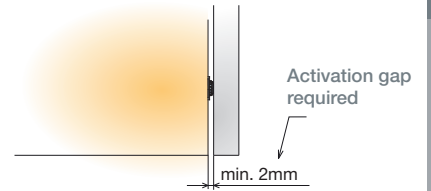
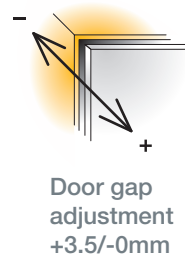

Drilling pattern

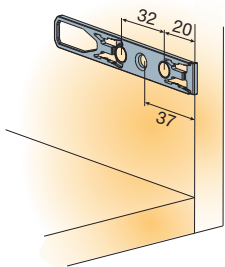

Mounting

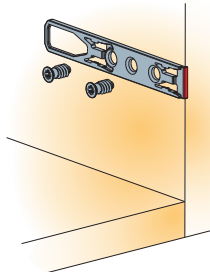

Depth adjustment

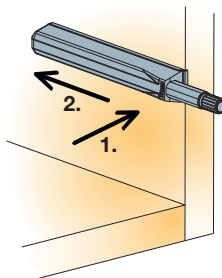
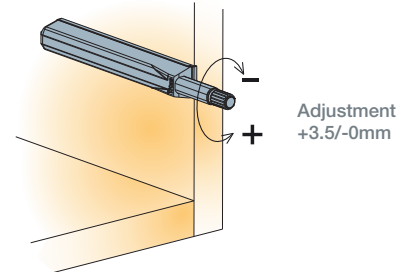

Positioning

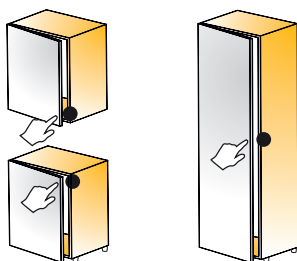

Mounting position close to the 'touch opening point' on the side opposite to hinges.

For application on cabinets with more than 2 hinges and cabinets with narrow doors we recommend a trial mounting.

Push Latch S3

For wood doors

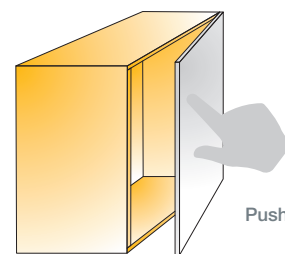

Tehnicl details

Item number

Dusty white

Anthracite

Black

Push Latch S3 drill-in

915-9276 →

356

383

390

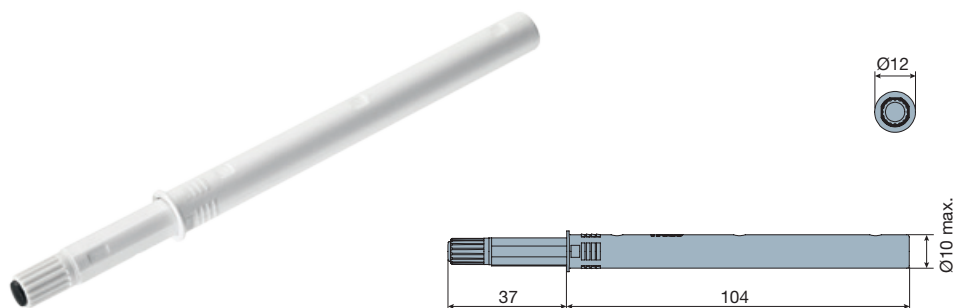

200 Pcs Made of plastic

Push Latch S3 routed

915-9278 →

356

383

390

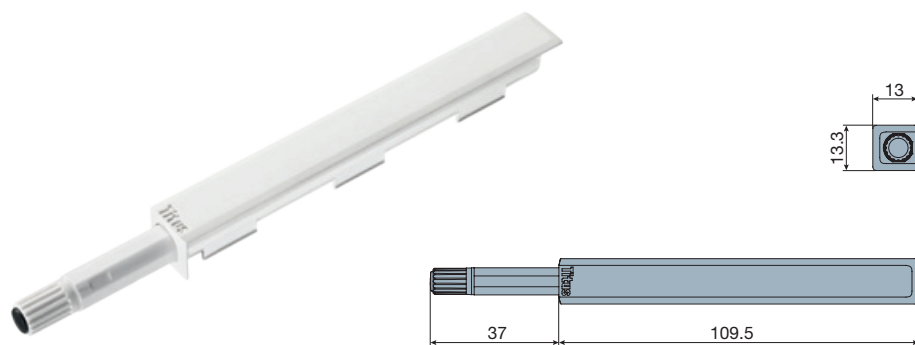

200 Sets Made of plastic

Drilling jig for Push Latch S3 drill-in



915-9900-072

1 Pc

- Soft and silent push opening
- Door gap adjustment ensures reliable closing and consistent performance
- Positioning lip assures accurate position

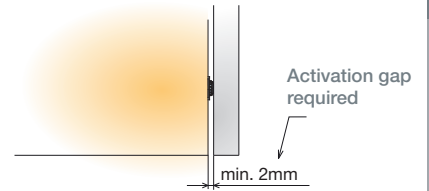
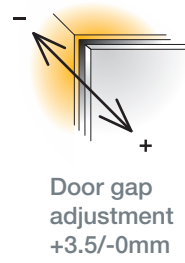

Drilling pattern

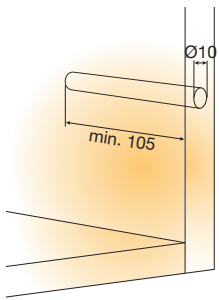

Mounting

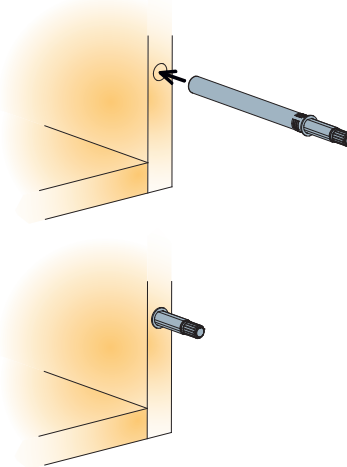

Depth adjustment

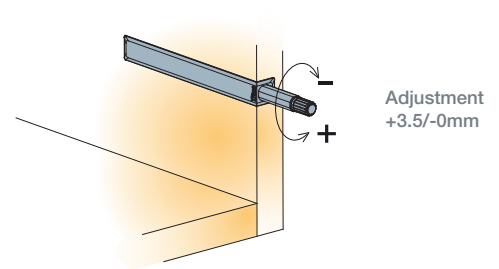
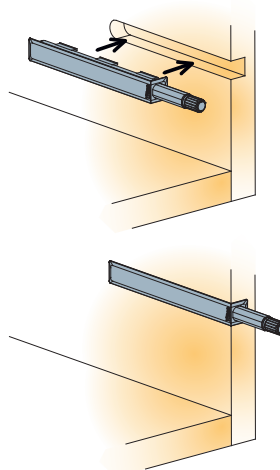
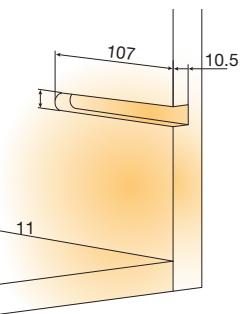
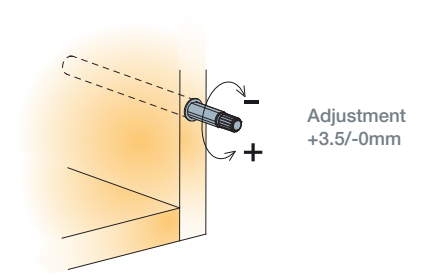

Positioning

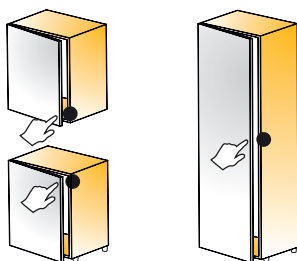

Mounting position close to the 'touch opening point' on the side opposite to hinges.

For application on cabinets with more than 2 hinges and cabinets with narrow doors we recommend a trial mounting.

Push Latch S2

For wood doors

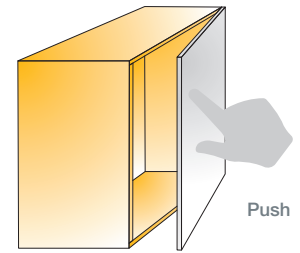

Push Latch S2



Push Latch S2



Linear mounting plate with lip

 200 Sets Made of steel and plastic

Item number

Silver grey

915-0W34 →

381

Set consists of:



 200 Sets

Fixing screws for mounting plates

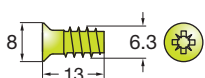

Euro screws
821-6323-050

 5000 Pcs

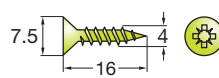

Chipboard screws
820-6328-050

 10000 Pcs

- Bounceless and reliable door opening and closing
- Safety detachment feature of the mechanism from its mounting plate
- Depth adjustment assures reliable and consistent push-to-open action
- Compatibility with damped or non-damped hinges ensures soft landing of the door

i Push latch S2 works with standard hinges with and without damping

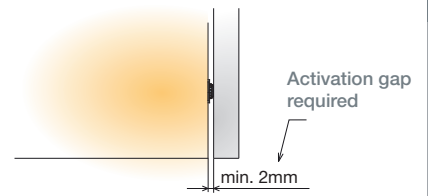
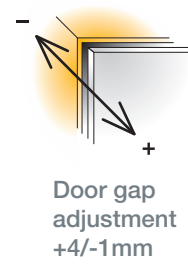

Drilling pattern

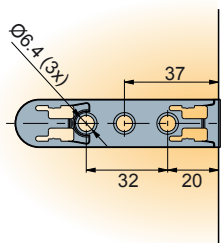

Mounting

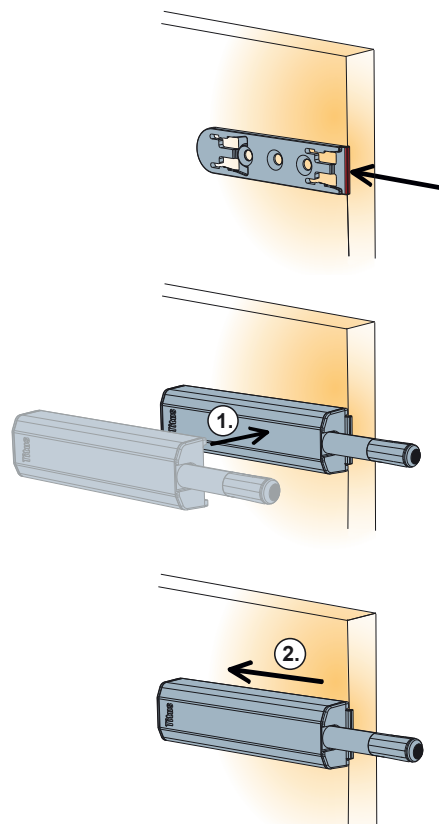

Depth adjustment

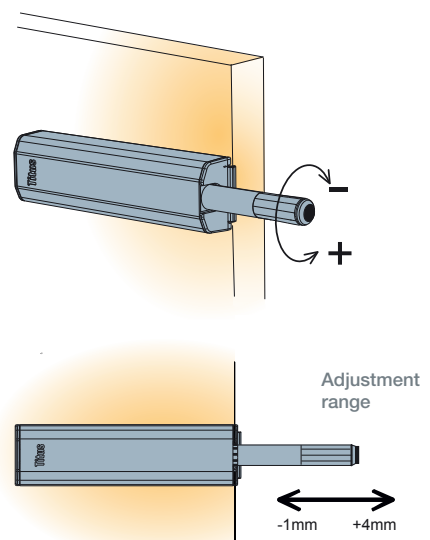

Positioning

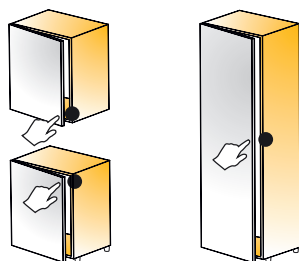

Mounting position close to the 'touch opening point' on the side opposite to hinges.

For application on cabinets with more than 2 hinges and cabinets with narrow doors we recommend a trial mounting.

Push Latch

For wood doors and drawers

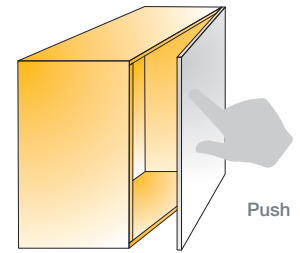

Push Latch



Push Latch



Cruciform mounting plate



Linear mounting plate

	Spring force [N] (released)	Spring force [N] (loaded)	Item number	Silver grey
With bumper	10	20	915-0X59 →	381
With bumper	13	27	915-0320 →	381
With magnet	10	20	915-0D22 →	381
Linear mounting plate			915-4175 →	381
Cruciform mounting plate			915-4183 →	381
Sets:				
	Cruciform m. plate		Linear m. plate	
With bumper	915-0X59-381-K1		915-0X59-381-K2	
	200 Sets		200 Sets	
With magnet	915-0D22-381-K1		915-0D22-381-K2	
	200 Sets		200 Sets	

200 Pcs Made of steel and plastic

Fixing screws for mounting plates

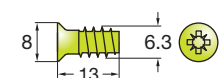

Euro screws
821-6323-050
 5000 Pcs

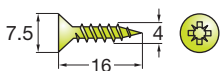

Chipboard screws
820-6328-050
 10000 Pcs

Accessories for Push latch with magnet (nickel plated steel)

Counter plate self adhesive

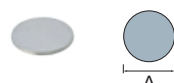

A = Ø15

915-7159-050 500 Pcs

Counter plate

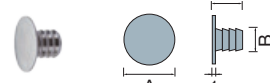

A = Ø10 B = Ø5

915-7196-050 500 Pcs

A = Ø15 B = Ø8

915-7190-050 500 Pcs

Knock-in Counter plate

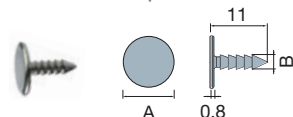

A = Ø10 B = Ø2.8

915-7199-050 500 Pcs

- Effortless opening with just a light touch
- Depth adjustment ensures reliable closing and consistent performance in case of inaccurate drilling
- 'Safety click' feature for easy detachment of the mechanism from its mounting plate

i Push latch with bumper works with standard hinge
 Push latch with magnet works with reverse spring hinges or unsprung hinges

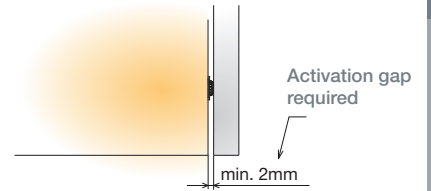
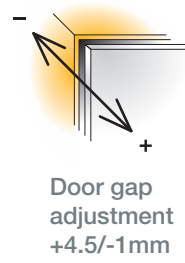

Drilling pattern

Dimensions

Depth adjustment

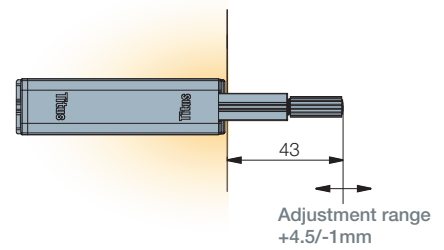
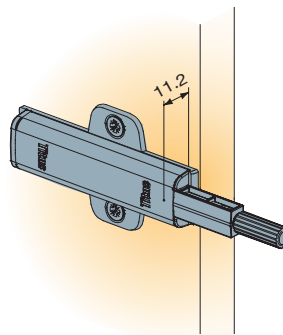
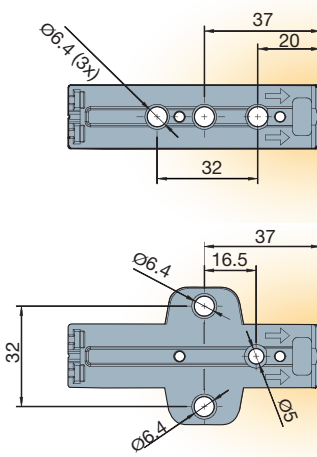

Positioning

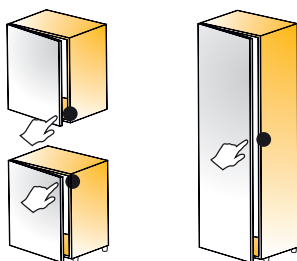

Mounting position close to the 'touch opening point' on the side opposite to hinges.

For application on cabinets with more than 2 hinges and cabinets with narrow doors we recommend a trial mounting.

PushOpen Short

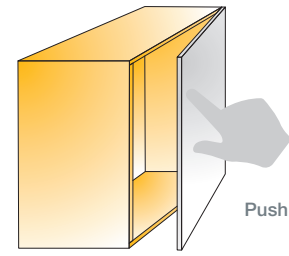

Stroke [mm]	Item number	White	Grey	Lead grey	Black
-------------	-------------	-------	------	-----------	-------

PushOpen Short

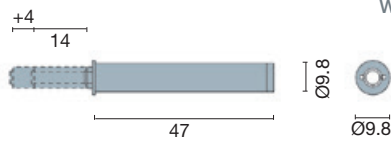

With bumper

14	915-7187 →	350	380	383	390
----	-------------------	-----	-----	-----	-----

With magnet

14	915-7185 →	350	380	383	390
----	-------------------	-----	-----	-----	-----

100 Pcs Made of steel and plastic

Housing Short

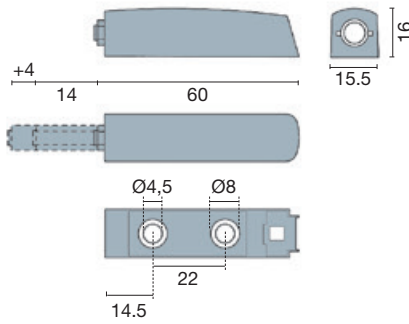

915-7192 →	350	380	383	390
-------------------	-----	-----	-----	-----

100 Pcs Made of plastic

Fixing screws for housing

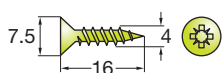

Chipboard screws
820-6328-050
10000 Pcs

Accessories for PushOpen with magnet (nickel plated steel)

Counter plate self adhesive



A = Ø15 **915-7159-050** 500 Pcs

Counter plate

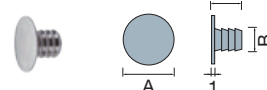

A = Ø10 B = Ø5 **915-7196-050** 500 Pcs

A = Ø15 B = Ø8 **915-7190-050** 500 Pcs

Knock-in Counter plate

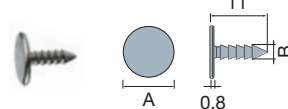

A = Ø10 B = Ø2.8 **915-7199-050** 500 Pcs

- Effortless opening with just a light touch
- Depth adjustment ensures reliable opening



PushOpen with bumper works with standard hinge
 PushOpen with magnet works with reverse spring or unprung hinges

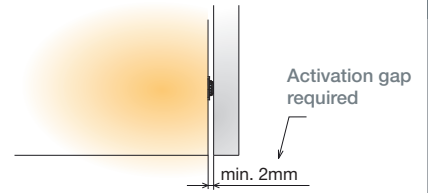
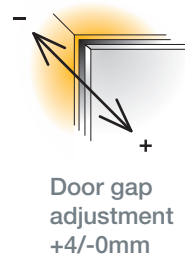

Drilling pattern and mounting procedure

Depth adjustment

Door gap adjustment

Without housing

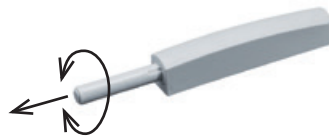
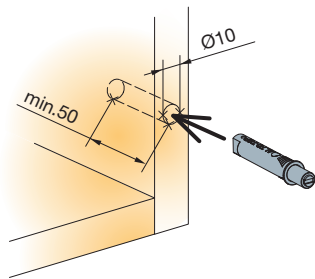

Adjustment made by rotating the depth adjustment screw

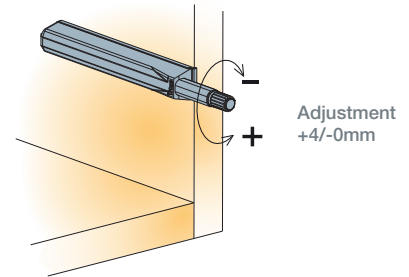

With housing

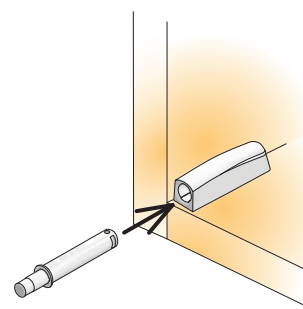
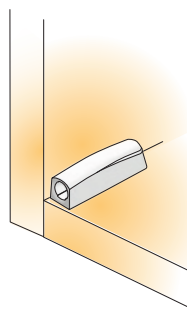
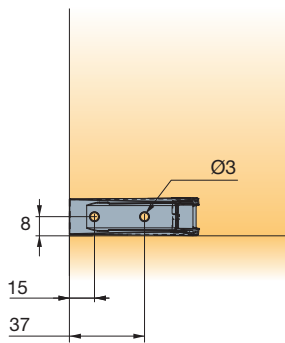

Application on door for Counter plates

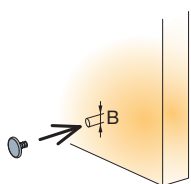

Pre-drilled hole ØB x 10mm

Application on door for Counter plate with double side tape and knock-in counter plate

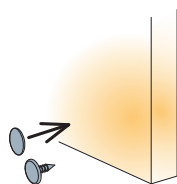

Sticking or knock-in position

Positioning

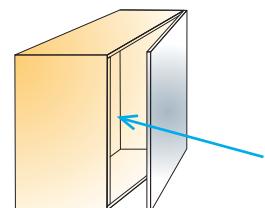

Close to the 'touch opening point' on the side opposite to hinges

PushOpen Long

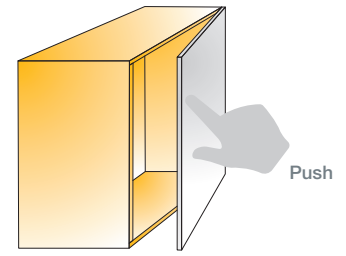

Stroke [mm]	Item number	White	Grey	Lead grey	Black
-------------	-------------	-------	------	-----------	-------

PushOpen
Long

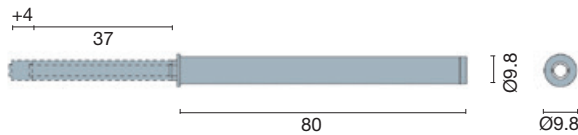

With bumper

37 **915-7188** → 350 380 383 390

With magnet

37 **915-7186** → 350 380 383 390

100 Pcs Made of steel and plastic

Housing
Long

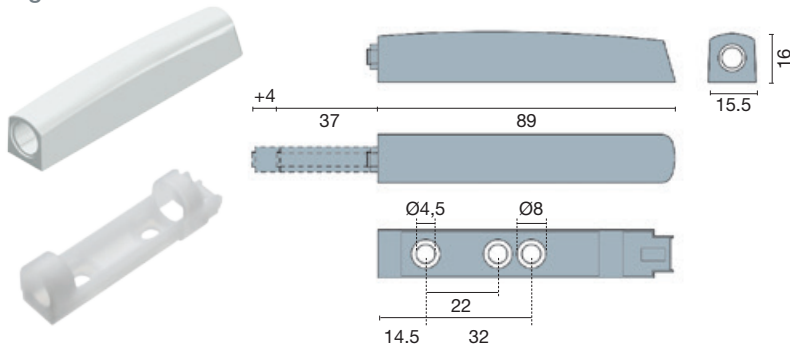

915-7193 → 350 380 383 390

100 Pcs Made of plastic

Fixing screws for housing

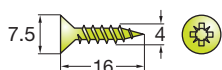

Chipboard screws
820-6328-050

10000 Pcs

Accessories for PushOpen with magnet (nickel plated steel)

Counter plate self adhesive



A = Ø15

915-7159-050 500 Pcs

Counter plate

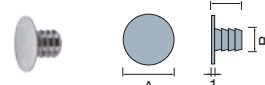

A = Ø10 B = Ø5

915-7196-050 500 Pcs

A = Ø15 B = Ø8

915-7190-050 500 Pcs

Knock-in Counter plate

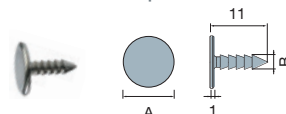

A = Ø10 B = Ø2.8

915-7199-050 500 Pcs

- Effortless opening with just a light touch
- Depth adjustment ensures reliable opening



PushOpen with bumper works with standard hinge
 PushOpen with magnet works with reverse spring or unprung hinges

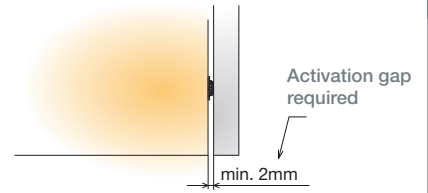
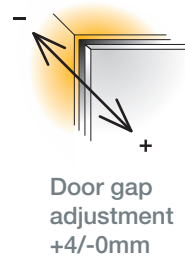

Drilling pattern and mounting procedure

Depth adjustment

Door gap adjustment

Without housing

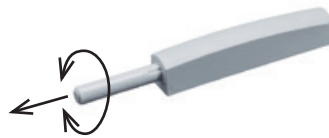
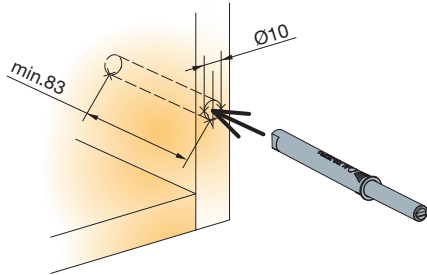

Adjustment made by rotating the depth adjustment screw

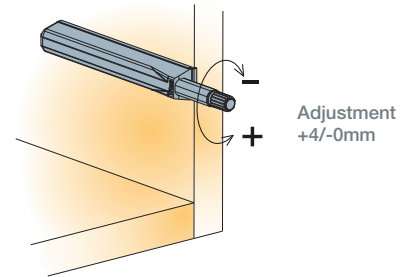

With housing

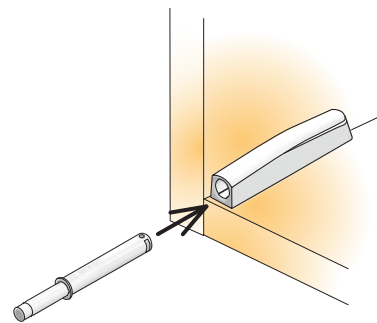
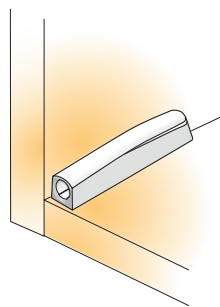
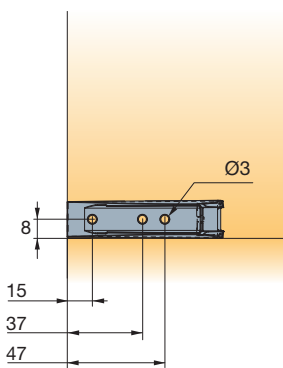

Application on door for Counter plates

Application on door for Counter plate with double side tape and knock-in counter plate

Positioning

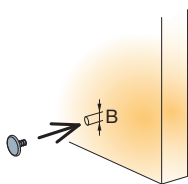

Pre-drilled hole
 ØB x 10mm

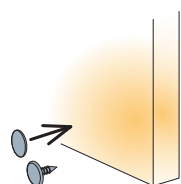

Sticking or knock-in
 position

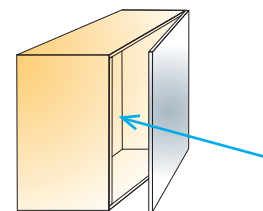

Close to the 'touch opening point'
 on the side opposite to hinges

